

Hakki Pilke

OH 27

LOG SPLITTER

- Instructions for assembly, operation and maintenance
- EU Declaration of Conformity
- Safety instructions
- Warranty terms



The operator must read and understand these instructions before operating the log splitter!

MAASELÄN KONE OY
Valimotie 1, 85800 Haapajärvi
tel.+358 (0)8 7727300
info@hakkipilke.fi
www.hakkipilke.fi

TABLE OF CONTENTS

GENERAL SAFETY INSTRUCTIONS	4
WARNING SYMBOLS	5
Commissioning a New Machine	8
Conveyor Work Position.....	9
Conveyor Transport Position	11
The Machine from the Front	12
The Machine from the Rear	12
Filling cap of the oil tank	12
Connecting the Machine to a Tractor.....	13
Electrically Driven Firewood Processor	14
Start and Stop Buttons.....	15
Operation and Control of a Hydraulic Splitting System	16
Starting the Splitting Movement	17
Splitting Blade Adjustment, Dismounting and Reassembly	17
Wood Length Adjustment.....	18
Emergency Stop	18
Test Run	20
Before Processing Firewood	20
Processing the Firewood	21
Safety Precautions for Cutting Trees:	22
Splitting the Last Cut Piece of Wood.....	24
Splitting a Split Piece of Wood.....	24
Removing Wood Caught in the Splitting Blade.....	24
Using the Conveyor	25
Finishing the Work.....	26
Transferring the Machine.....	26
Cutting Blade	27
Sharpening	27
The setting must be approx. 0.7 mm.....	27
Installing the Conveyor Drive Belt	30
Tightening Angular Gear Drive Belts in Model TR60	31
Belt tightness:.....	31
Tightening Angular Gear Drive Belts in Model TRS60	31

Machine Lubrication	32
Hydraulic Oil.....	32
Angular Gear.....	32
Splitting Mechanism	32
Operation.....	33
Adjustments	34
Adjusting the Travel of the Splitting Beam	34
Towards the initial position.....	34
The stroke is shortened	34
Splitting beam	34
Disturbances in the Splitting Mechanism, Their Reparation and Prevention	35
Hydraulic System Pressure Adjustment.....	36
Storing the Machine	36
Technical Specifications:	37
EU DECLARATION OF CONFORMITY OF MACHINE.....	38
Manufacturer: Maaselän Kone Oy	38
Guarantee terms	39
The guarantee covers	39
The guarantee does not cover	39

GENERAL SAFETY INSTRUCTIONS

Great care must be taken in the operation of this machine as well as its connection to a power source, such as a tractor, so that neither the person connecting it nor other persons nearby are subjected to injury.

In order to avoid accidents, the machine must not be operated by persons who are tired, intoxicated or under the influence of drugs or not sufficiently capable of controlling their actions.

The connection of the machine to the power source must be carried out by only one person at any one time.

The risk zone around the machine is 10 metres. Except for the operator, no other person is allowed within this area during connection and operation.

If persons other than the operator remain within the risk zone, the operator must make them aware of the dangers related to the operation of the machine.

The work site and its surroundings must be prepared prior to operating the machine to ensure safe working conditions. The area must be sufficiently lit for operation. If the light is scarce, the machine must not be used without sufficient and appropriate additional lighting.

The Hakki Pilke Firewood Processor is designed for making firewood of lopped trees and other lopped and pre-processed wood, such as pre-cut logs. Do not process wood material that has been processed in any other way, such as construction waste. The manufacturer of the machine is not responsible for any damages or injuries that processing such wood may cause to the machine or operator.

The work capacity of the machine, i.e. the maximum wood diameter of 25 cm and the maximum wood length of 55 cm, must not be exceeded.

The machine must not be operated, if the operator is not:

- familiar with these instructions;
- familiar with risk situations that may occur during the operation of the machine;
- able to act, should a dangerous situation occur during operation.

If the machine is faulty or contains a broken part that the operator is not able to repair or replace, the operator must contact the seller, manufacturer or importer of the machine.

The operator must always check all components before connecting the machine to the tractor or operating it. Under no circumstances should the machine be used if even a small amount of wear and tear is detected in its structure or components! The faulty parts must be repaired or replaced with new ones!

WARNING SYMBOLS



DANGER ZONE



BEWARE OF THE CUTTING
BLADE



ONLY ONE PERSON AT A
TIME IN THE WORK AREA



SHUT DOWN BEFORE
MAINTENANCE



BEWARE OF MOVING
PARTS



RISK OF ENTANGLEMENT
WITH THE CARDAN
SHAFT



RISK OF CRUSHING



DO NOT GO UNDER THE
CONVEYOR
MAX CONVEYOR TILT
ANGLE



BEWARE OF THE
SPLITTING BLADE



LUE OHJEKIRJA ENNEN KÄYTTÖÄ

READ THE MANUAL BEFORE
USE



KÄYTÄ SUOJAVARUSTEITA

USE PROTECTIVE
EQUIPMENT



KÄYTÄ SUOJAVARUSTEITA

USE PROTECTIVE
EQUIPMENT



TARTU PUUTA AINA KYLJISTÄ

ALWAYS GRAB A LOG BY
THE SIDES

**MAX
410 RPM**

MAX RPM



Scale



HYDRAULIÖLJY

HYDRAULIC OIL



PYÖRIMISSUUNTA VASEMMALLE

LEFT ROTATION



PYÖRIMISSUUNTA OIKEALLE

RIGHT ROTATION



NOSTOKOHTA TRUKILLE

LIFTING POINT FOR
FORKLIFT



NOSTOKOHTA KOUKULLE

LIFTING POINT FOR HOOK



HÄTÄPYSÄYTYS

EMERGENCY STOP

Machine Lifting Points

The machine includes lifting points designed for a forklift fork and a line or chain. The following figure on the left shows the lifting points for a line or chain.

The figure on the right shows the lifting points for a forklift fork. Always insert one of fork prongs through the frame preventing sideslip.

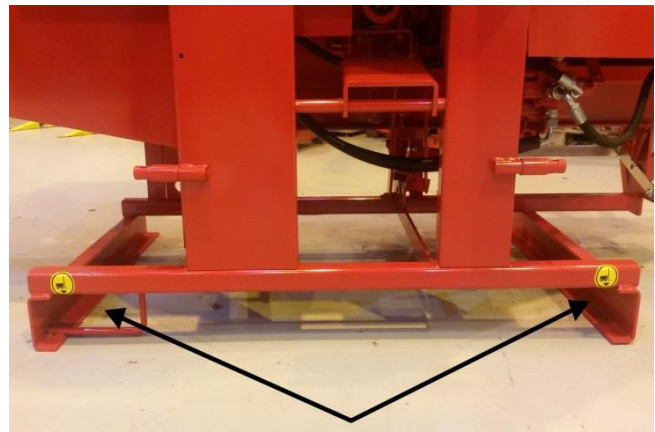
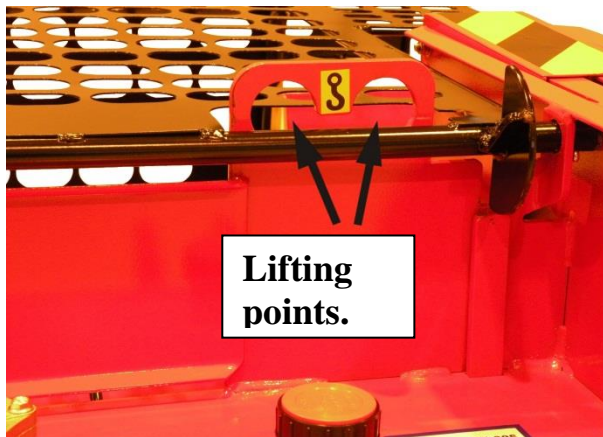

Commissioning a New Machine

After unpacking the machine, dispose of the packaging material in an environmentally friendly way.

Install the loose parts supplied with the machine:

1. Place the cross-cut cradle extension into the square pipe in the cradle frame.



2. Adjust the extension to the desired length and lock it in place with a locking nut.

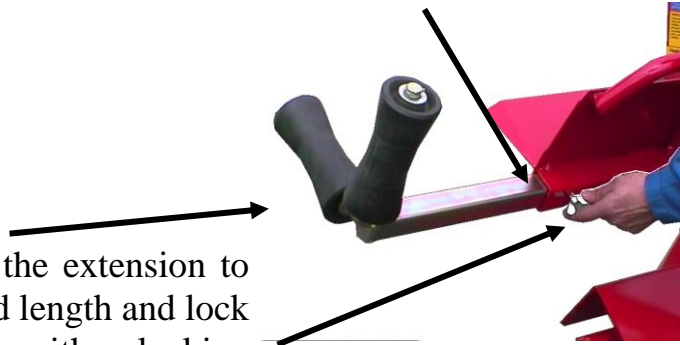

3. Adjust the extreme position of the cradle (towards the user) with the two nuts in the lower part of the cradle. There should be approx. 3 mm between the cradle cover and the rocking cover.

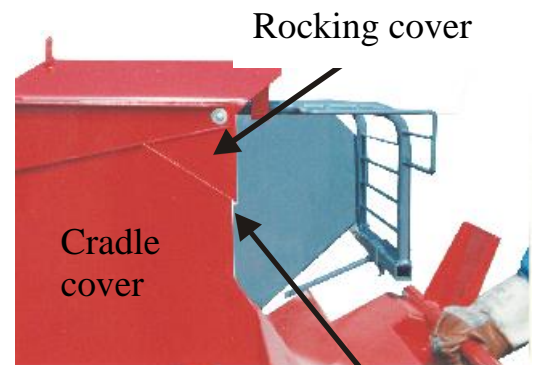

4. Install the adjustment lever of the splitting blade onto the joint pin on the machine frame. Add the washer and lock the parts in place with a split cotter.

5. Install the winch handle by screwing the handle on the root of the shaft.
Screw the locking nut of the handle on the shaft.

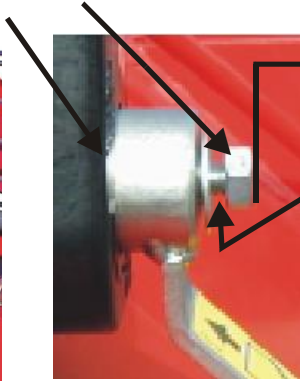
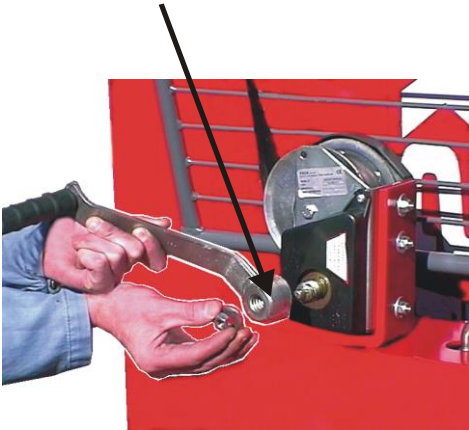

Tighten the nut evenly with the winch shaft.

There should be approx. 5 mm between the nut and the handle frame.

Winch operation:

When the handle is turned clockwise, the brake loosens and the strap tightens on the spool. When the handle is turned counter-clockwise, the brake engages and the strap loosens from the spool.

Conveyor Work Position

1. Make sure that the winch is locked to the removal conveyor and that hook latch is intact as shown below.

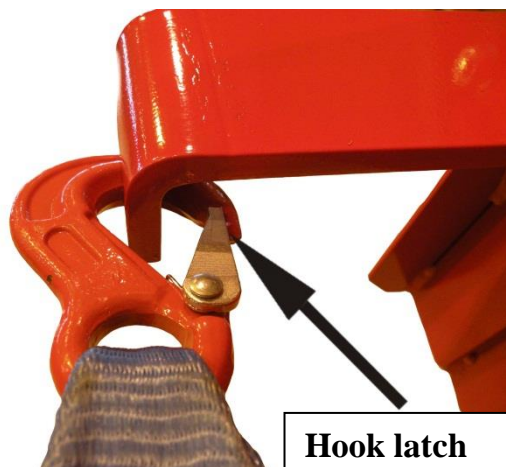



2. Unwind some line from the winch.



3. Push the conveyor towards the machine and release its lock by lifting the locking handle.



4. Pull the conveyor until the winch line tightens.

5. Lower the conveyor with the winch.

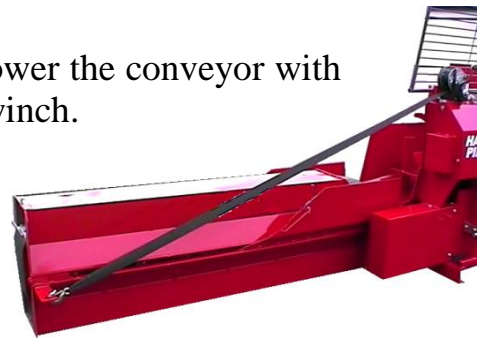

6. Extend the conveyor to its full length.



7. Adjust the conveyor to the desired inclination with the winch and lock the extension with the lock at the bottom of the conveyor.



8. Turn the belt holder to the side of the conveyor.

Conveyor Transport Position

Bring the conveyor into the transport position by reversing the steps described in section “Conveyor Work Position”.

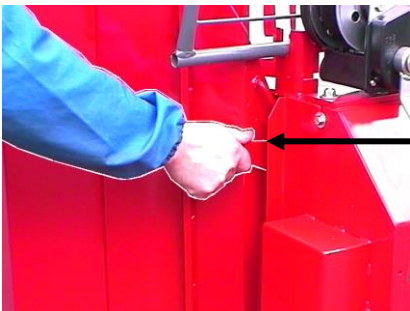

Always ensure that the conveyor is in the transport position before transporting the machine.

The Machine from the Front

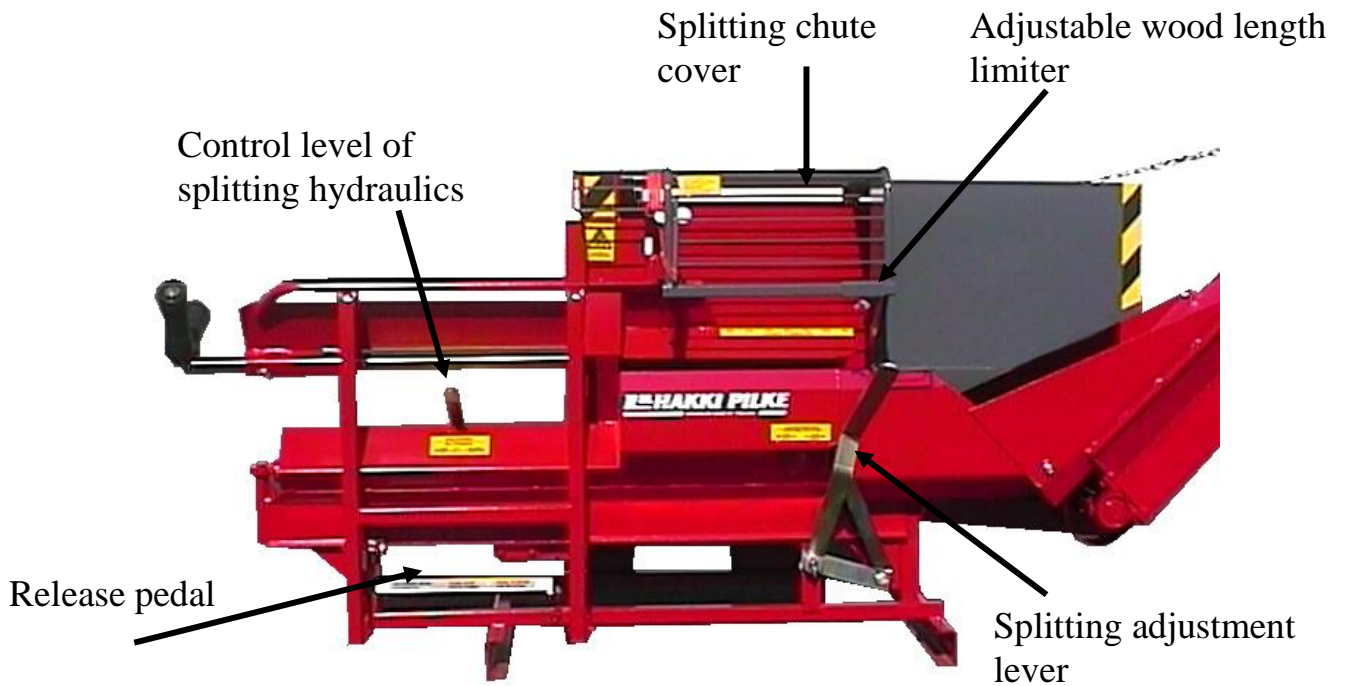

The Machine from the Rear

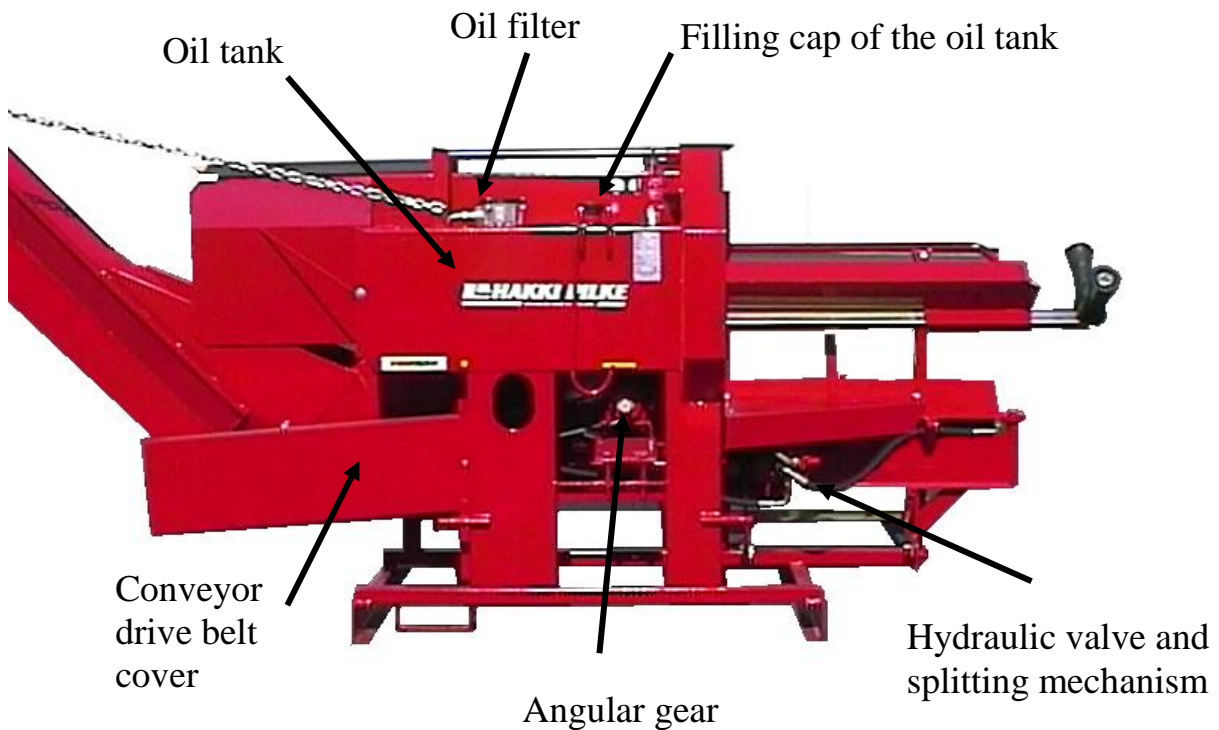

Connecting the Machine to a Tractor

Always make sure you are on your own when connecting the machine. Ensure there are no other persons or animals in the tractor cabin, who could accidentally touch the controls during the connection process. Check all connection parts of the machine and tractor before connection. Do not connect the machine to faulty devices or parts.

Always carry out the connection in a calm manner and in one go, without interruption. Secure the locking of the pins with appropriate cotters. After finishing the connection, check that the procedure has been completed successfully.

When connecting the articulated shaft, follow the instructions on safe connection provided by the shaft manufacturer. Connecting an unprotected shaft to the machine is absolutely forbidden!

The maximum power requirement of the machine is 7.5 kW, and the articulated shaft should be dimensioned accordingly.

The following figure shows the tractor attachment points.

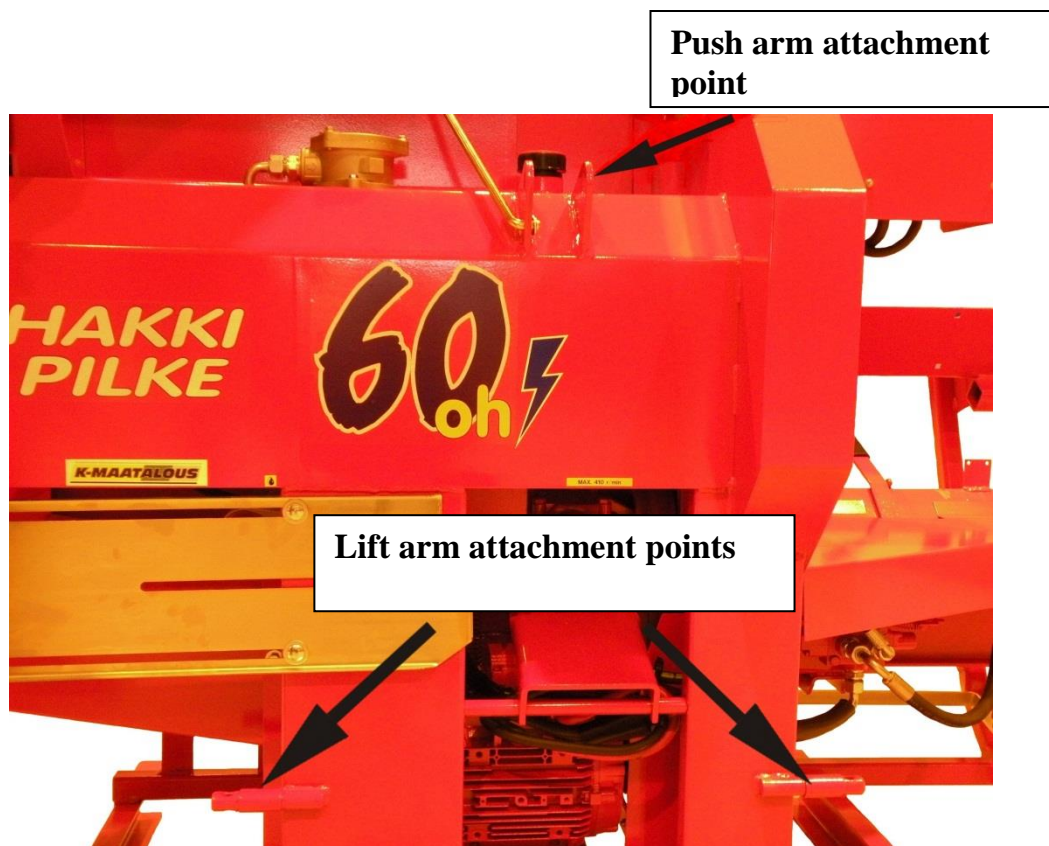

Electrically Driven Firewood Processor

In addition to the instructions in this manual on the safe operation and service of a tractor driven machine, the following points must be observed when operating the electrically driven machine model TRS 60:

The machine must be placed on a base from which it cannot move or fall during operation.

The electric motor IP- rating is 55. The fuse rating is min. 16A slow.

The machine is equipped with a male contact. When plugging in the electrical cable, ensure that:

- the capacity of the cable is high enough;
- the cable and plug are intact;
- the cable is led from the socket to the machine by a route that protects the cord from damage and ensures it cannot cause damage or injury outsiders;
- when the cable is installed across a passageway, it is dug in the ground and covered so that the users of the passageway cannot come into contact with the cable;
- the cable is led directly from the plug contact to the contact on the machine (see the following figure) and never installed on the side where the operator is processing firewood.

Before starting the machine, make sure that the angular gear cover is in place so that it is not possible to touch the gear.

The machine must absolutely not be operated if this cover is not in place.



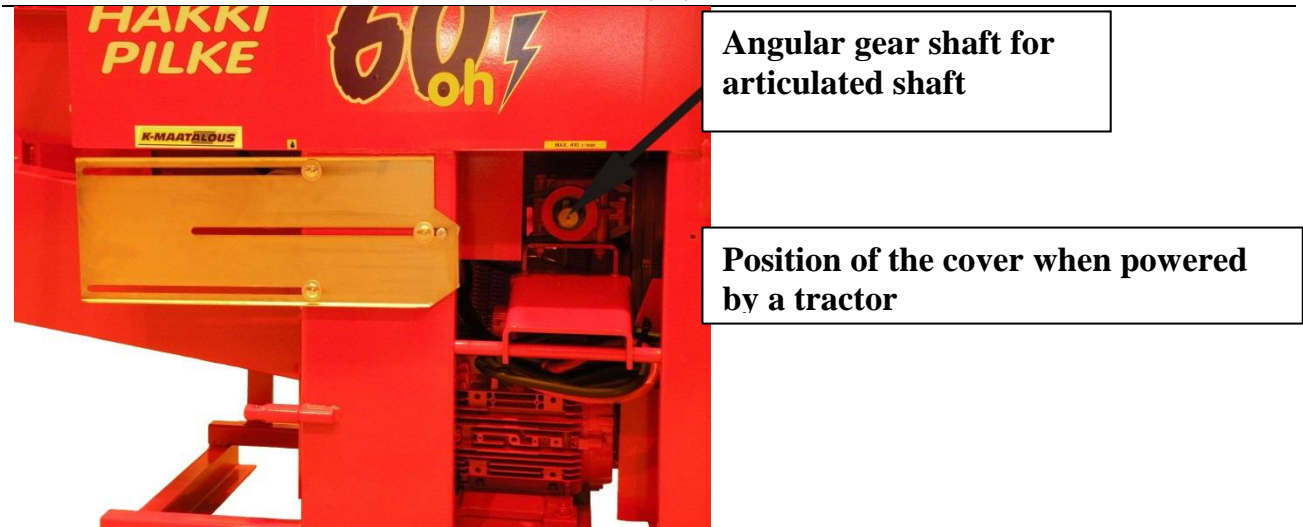

Angular gear shaft for articulated shaft

Position of the cover when powered by a tractor

Start and Stop Buttons

The start box is on the left hand side of the cutting blade.



The machine **start button** is the **green** button on the box.

The **red** button on the box is the **stop button**.

A tractor-driven machine cannot be halted from the red stop button of an electrically driven machine!!!

Make sure that the motor starts running in the correct direction when you start it.

The direction of rotation is correct if the teeth of the cutting blade run downwards seen from the front of the machine. The direction is incorrect if the teeth run upwards, and **in this case the machine must be stopped immediately**. Only persons authorised to do so may change the rotation direction.

An electrically driven machine must always be stopped for transportation.

In order to prevent children and other outsiders from starting the machine, the electrical cable must always be disconnected during breaks or at the end of firewood processing.

If an electrically driven machine is driven by a tractor, all instructions in this manual on the safe operation of a tractor-driven machine must be followed.

Operation and Control of a Hydraulic Splitting System

The position of the control lever is shown in section *The Machine from the Front*.

When the control lever is in the *IN OPERATION* position, the splitting system is in operation and the splitting chute cover cannot be opened. The mechanism at the joint prevents it.

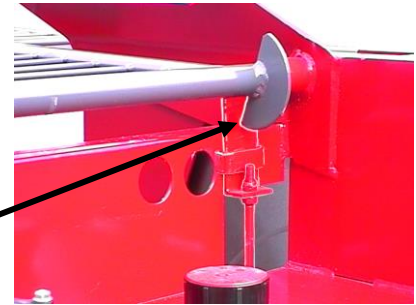

When the splitting lever is in the *STOP* position, the splitting system is not in operation. The opening mechanism is unlocked and it is possible to open the cover.

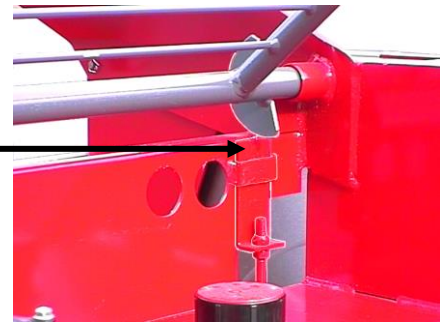

Do not operate the machine if the locking mechanism is out of order.

When the control lever is pushed to the *REVERSE* position, the splitting cylinder retracts to its initial position. This function is used if the cylinder is not able to split the wood and the cylinder must be reversed.

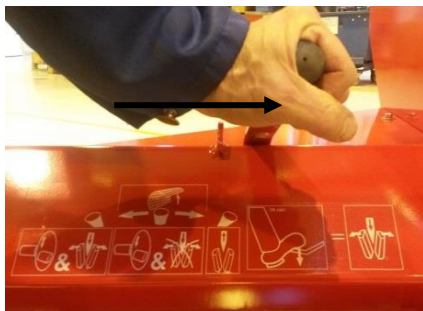

Starting the Splitting Movement



Automatically: when the cut-off wood hits the splitting release lever in the splitting chute.



By foot with the pedal: when test running the machine or if automatic splitting is out of order.

It is absolutely forbidden to start the splitting movement by activating the automatic release lever with a hand, piece of wood or any other object.

Splitting Blade Adjustment, Dismounting and Reassembly

The splitting blade can be adjusted vertically inside the splitting chute. The size of the wood determines the vertical position of the horizontal blade. The most important thing is to ensure that the blade cross hits the wood in the middle, thus splitting the wood into equally sized pieces. The adjustment is the same for blades that split wood into 4 pieces and for blades that split wood into 6 pieces (optional).

The adjustment lever is released from its locking by pushing downwards. The vertical position of the blade is adjusted by moving the lever sideways. When the blade is in the desired position, the lever is placed in the locking grooves on the machine frame.

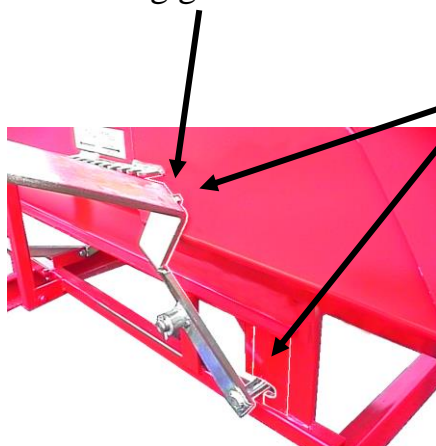

The blade can be released from its adjustment lever and removed by moving the blade to its lowest position.

Remove the blade for sharpening or for making firewood of logs without splitting them. **Reassemble** the blade by carrying out the process in reverse order.



Wood Length Adjustment

The length of the wood being split can be adjusted progressively from approx. 20 cm to 55 cm using a mechanical wood measuring device attached to the splitting chute cover (see the following figure). The location of the measuring device rod determines the length of the wood being split. It is adjusted as follows:

1. Loosen the adjuster clamping screw.
2. Move the measuring device rod to the desired position and tighten the clamping screw.



Emergency Stop

The lower part of the machine has an emergency stop pedal at the operator's position.

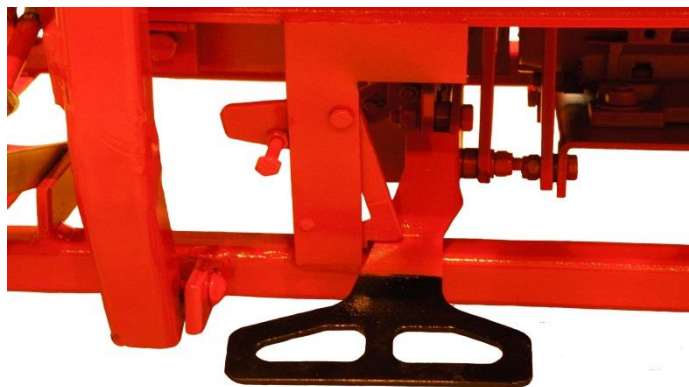

If a dangerous situation occurs during machine operation, push the pedal down as shown in the following figure.



After stopping the machine with the emergency stop pedal, calmly switch off its power source, e.g. the tractor.

REMEMBER! The emergency stop pedal has stopped the machine so there is no need to rush, causing another dangerous situation.

IN A DANGER SITUATION:

- 1. STOP THE MACHINE WITH THE EMERGENCY STOP PEDAL.**
- 2. CALMLY SWITCH OFF THE MACHINE'S POWER SOURCE!!!**
- 3. REMOVE THE DANGER.**

After removing the danger, activate the machine by releasing the locking latch and by lifting the emergency stop pedal to its upper position.

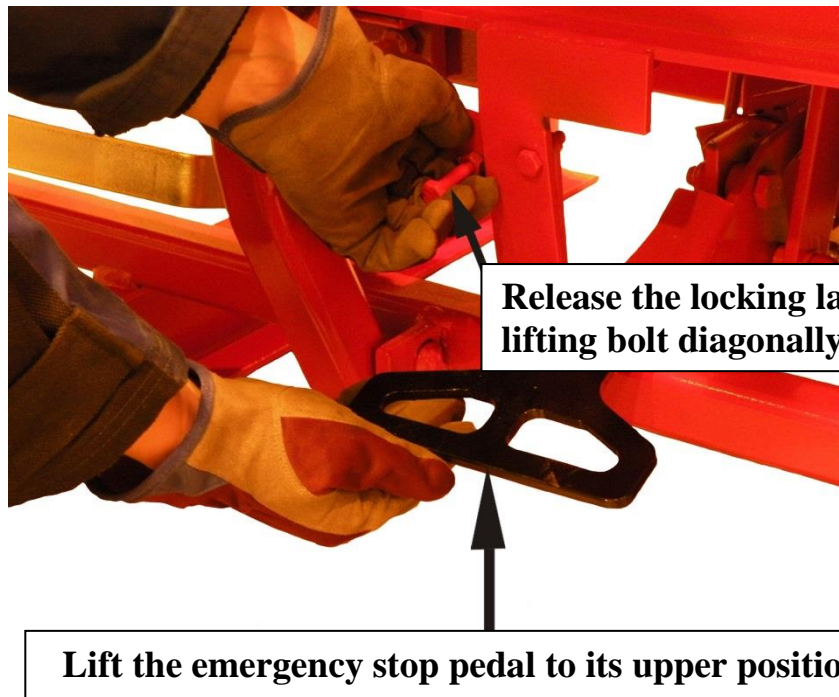

Test Run

A test run must always be carried out before putting the machine into operation.

1. Make sure that the conveyor is in the work position and that the splitting chute cover is down.
2. Start the tractor and let the engine idle.
3. Start the rotation of the tractor's power take-off by lifting the clutch pedal slowly and smoothly. Let the machine run for a while.
4. For an **electrically driven** machine, let the machine run for a few minutes **depending on air temperature** to warm up the oils before starting the test run.
5. Bring the splitting control lever to the *In operation* position.
6. Start the splitting movement with the pedal. Repeat the movement several times and check that the machine is operating normally. Should there be any faults, repair them.
7. Test the functions described in section *Operation and Control of a Hydraulic Splitting System*.

If the functions are working correctly, you can start processing firewood as instructed below.

Before Processing Firewood

Do not begin to process firewood until you are fully familiar with the operating principle of the machine and the safety precautions.

When processing firewood, you should:

- wear safe clothes:
 - an outfit suitable for the weather conditions, with no hanging parts or strings that may get caught in the wood or the machine and thus cause an accident;
 - safety boots with non-slip soles;
 - gloves that give you a firm hold of the wood;
 - appropriate face and eye shields and hearing protectors;
- arrange the work site so that:
 - it is even and there is enough space for working;
 - the trees are at an appropriate distance from the machine;
- familiarise yourself with safe working practices.

Processing the Firewood

You can start processing firewood as soon as you have familiarised yourself with all safety precautions given above for the safe operation of the machine. Remember that **a test run must always be carried out before starting actual operation.**

1. Adjust the revolutions of the tractor's power take-off to 410 rpm.
2. Place the wood measuring device rod in the desired position (see page 16).
3. Place the splitting blade in the desired vertical position (see page 15).



4. Pull the splitting cradle to its rear position. Note! Always do this when transferring wood for cutting.

5. Lift the wood into the cross-cut cradle. **Observe the proper lifting position and mind your back (see page 20)!**

6. Transfer the wood against the length limiter.



7. Calmly push the cradle forward and keep pushing it until it reaches its extreme position. The cut wood remains in the trough formed by the cradle and the machine frame.

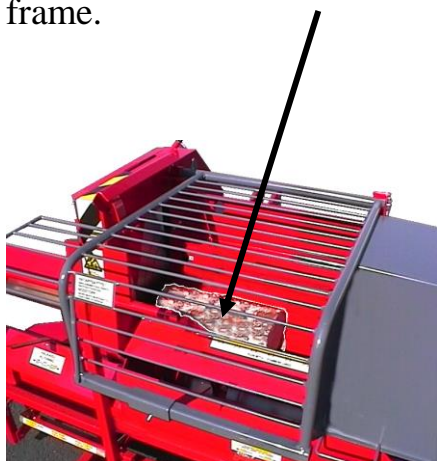

8. Calmly pull back the cross-cut cradle.

9. The cut wood drops down into the splitting chute and hits the automatic splitting release lever, which triggers the hydraulic splitting movement.

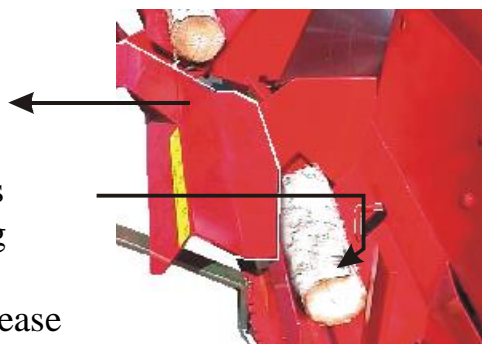

Safety Precautions for Cutting Trees:

- Only lift trees that you can safely lift onto the cross-cut cradle.
- Lift the largest trees onto the cross-cut cradle in two steps as described below.



- 1. Lift the root end onto the rollers (always feed the largest trees root end first)!**
- 2. Lift the top end. Lift with your legs, not with your back!**



- 3. Push the tree forward on the rollers.**

- Use a chain saw to pre-cut warped, gnarly, knotty and long trees and difficult-to-handle trees. Do not put them into the machine if you think they may cause a disturbance in the operation of the machine or a safety risk.
- Cutting several thin trees at one time in a bunch is absolutely forbidden!
- Stopping the cutting blade by pressing an object or a piece of wood against its side or teeth is forbidden.

- Support the tree being cut with a separate tree pusher as shown below.



1. Press the tree against the table with a tree pusher while pushing the tree forward.
2. Support the pushing with your left hand.

- It is absolutely forbidden to use a cracked blade.



LOOK OUT for blades that become exposed from the cover during cutting.

Splitting the Last Cut Piece of Wood

1. Bring the splitting control lever to the Stop position.
2. Open the splitting chute cover using the handles.
3. Drop the wood into the splitting chute.

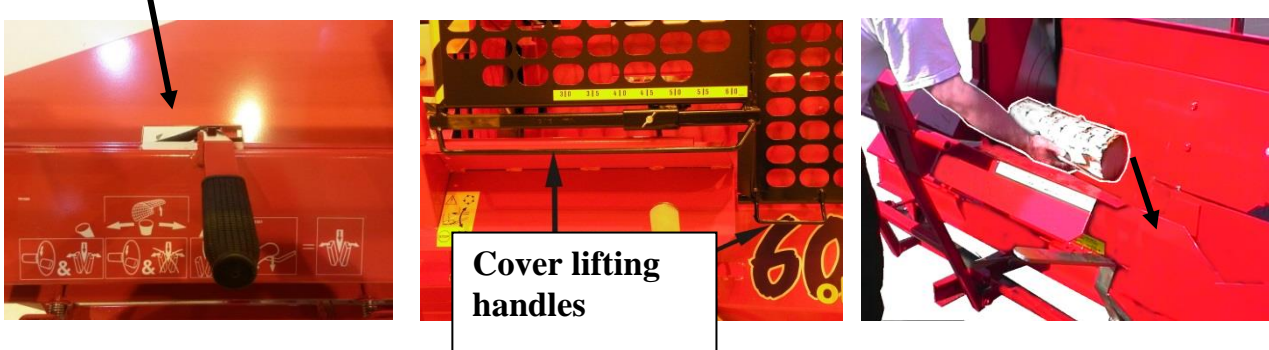

4. Close the splitting chute cover and bring the splitting control lever to the *In operation* position.
5. Start the splitting with the pedal.

Splitting a Split Piece of Wood

Do as instructed above in section *Splitting the Last Cut Piece of Wood* (page 22).

Removing Wood Caught in the Splitting Blade

If the splitting cylinder does not have the power to split the wood intended for splitting, do as follows:

1. Bring the splitting control lever to the *Reverse* position to return the splitting cylinder to its initial position.
2. Leave the control lever in the *Stop* position.
3. Open the splitting chute cover using the handles.

Look out for the splitting blade during the removal!

4. After removing the wood, move it to the side or put it back into the splitting chute and lower the splitting blade to its lowest position. The blade will then split the wood only into two pieces, for which the cylinder has enough power.
5. Lower the splitting chute cover and move the splitting control lever to the *In operation* position.
6. Start the splitting movement with the splitting pedal.

Using the Conveyor

Read the following sections of this manual:

- Bringing the conveyor into the transport position (page 9)
- Bringing the conveyor into the work position (page 7)
- Installing and adjusting the conveyor belt
- Adjusting the inclination of the conveyor (page 8)

In addition to the above-mentioned sections, the following must be observed:

- The work position of the conveyor must be adjusted to such an angle that the conveyor will be able to take away all finished firewood.

- **At its lowest position, the top end of the conveyor should be no lower than approx. 1.8 m above the ground.** If the conveyor is positioned lower than this, its transmission from the drive belt to the conveyor will be prevented.

- **The top end of the conveyor should be no higher than approx. 2.5 m above the ground.**

If the conveyor is at an angle steeper than this:

- pieces of wood may pile up behind the splitting blade in front of the conveyor and longer pieces may hit the conveyor chute bottom, thus damaging the conveyor;
- pieces of wood may tumble down from the top of the conveyor, thus creating a dangerous situation.

When processing firewood ensure that:

- the firewood falling down from the conveyor hits the intended platform, cage, bed, etc;
- the platform, cage, bed, etc. is not filled with more firewood than it is intended to hold;
- the firewood load to be transported is structured in a way that no firewood can fall from it during transportation;
- the distance between the top end of the conveyor and the firewood heap is no less than approx. 50 cm, to avoid the jamming the conveyor belt due to accumulated processed firewood;
- the conveyor is brought into the transport position even for short transfers (pages 7-9);
- if the machine is moved to another place at the chopping site, ensure the machine or conveyor does not hit the pile of chopped firewood;
- the lower end of the conveyor and splitting chute is kept free of wood waste.

Finishing the Work

1. Make sure there is no firewood in the splitting chute or on the conveyor belt.
2. Stop the power take-off of the tractor.
3. Slightly lift the machine with the lifting mechanism of the tractor and move the machine by approx. 0.5 m. Make sure that the conveyor does not hit anything.
4. Clean the machine, base and conveyor of wood waste.
5. Slowly lower the machine onto the ground and bring the conveyor into the transport position (page 9).

Transferring the Machine

When transferring the machine with a tractor:

- the conveyor must be in the transport position;
- the cross-cut cradle must be locked into the transport position as shown below;



- the necessary horizontal and vertical clearances required by the machine and conveyor must be observed. Also check that there are no persons or animals around the machine;
- the transportation must be carried out at such a low speed that no damage can occur to the machine, tractor or anything along the route;
- no extra items can be carried on top of the machine and conveyor.

Machine Maintenance



Note! The machine must always be disconnected from the power source (articulated shaft, electrical cable or both) before service!!!

Cutting Blade

Sharpening

- Keep the blade sharp because:
 - a sharp blade will cut the tree quicker and with less power;
 - a badly blunted blade becomes warm and may lose its pre-stressing, and thus sharpening it will require a lot more work;
 - less cracking between the teeth is formed in a sharp blade.
- Use for example a 6" v-cut barette file for sharpening.

- Keep the original:

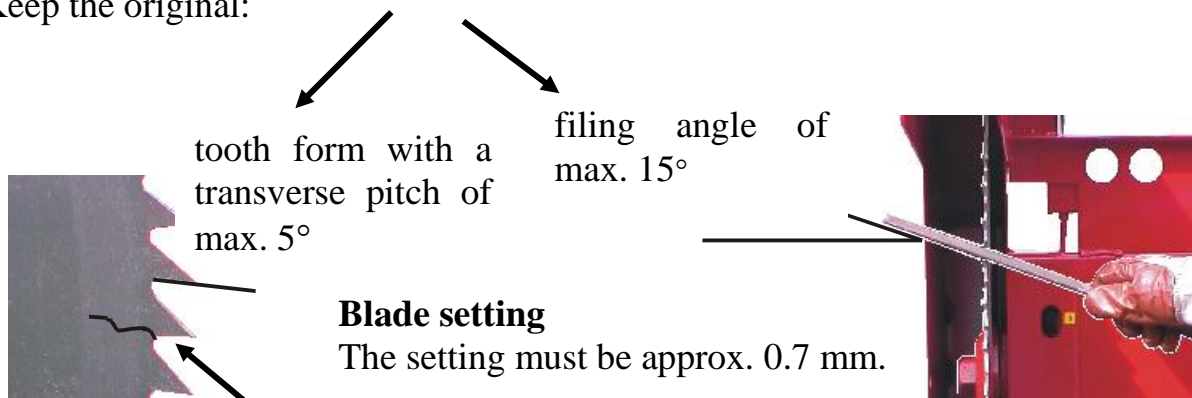

Rotating the blade is absolutely forbidden, if it has even a small hairline crack!

If you are using a hard blade, only have it serviced by a professional.

Pre-stressing the Blade

If the blade has lost its pre-stressing, take it to a professional with expertise in pre-stressing blades.

Blade removal

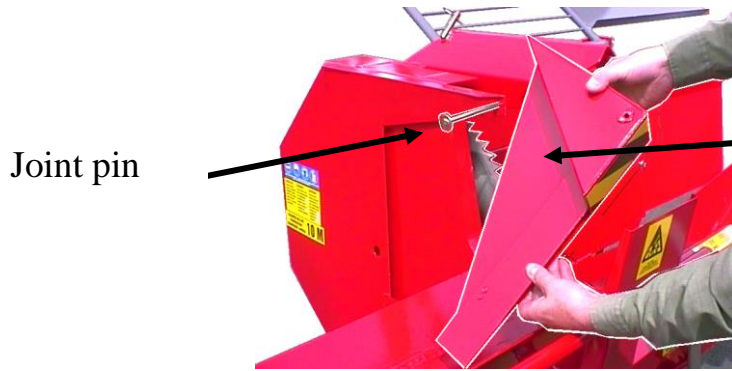

1. Remove the upper part of the blade cover by removing its joint pin.



2. Remove the two cradle inclination adjustment nuts.



3. Fell down the cradle.

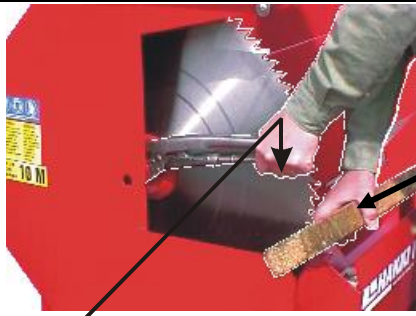

5. Open the attachment nut of the blade by pressing the wrench down.

4. Lock the blade in place by placing an angular piece of wood in the lower part of the cutting opening, between the machine frame and the teeth of the blade.

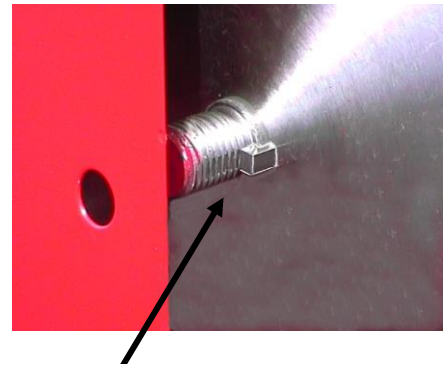

6. Remove the nut, the flange resting against the blade and the wedge on the shaft.



7. Remove the blade through the slots in the cover.
Remember to wear gloves when handling the blade!

Blade Attachment

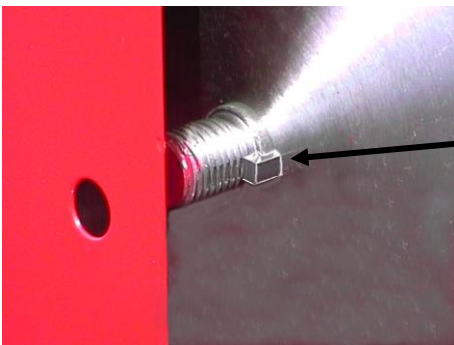

1. Put the blade in place through the same slots through which you removed it.
2. Install the wedge on the shaft and then install the blade support flange.
3. Turn the nut into position (left-handed thread).

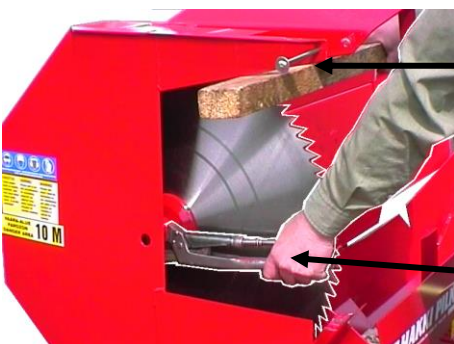

4. Lock the blade in place by placing an angular piece of wood in the upper part of the cutting opening, between the machine frame and the teeth of the blade.
5. Tighten the blade attachment nut by lifting the wrench.

6. Install the upper cover of the blade.

7. Lift the cross-cut cradle and put its two adjustment nuts in place.

8. Adjust the cradle to the correct angle (page 6).

Note! Always use the machine with blades complying with EN 847-1:1997!

Installing the Conveyor Drive Belt

1. Remove the drive belt cover from the machine frame by opening the attachment bolt and nut of the cover.



2. Place the belt on the conveyor drive pulley.

Make sure that the belt tensioning wheel is pressing on the uppermost belt, on its upper side.

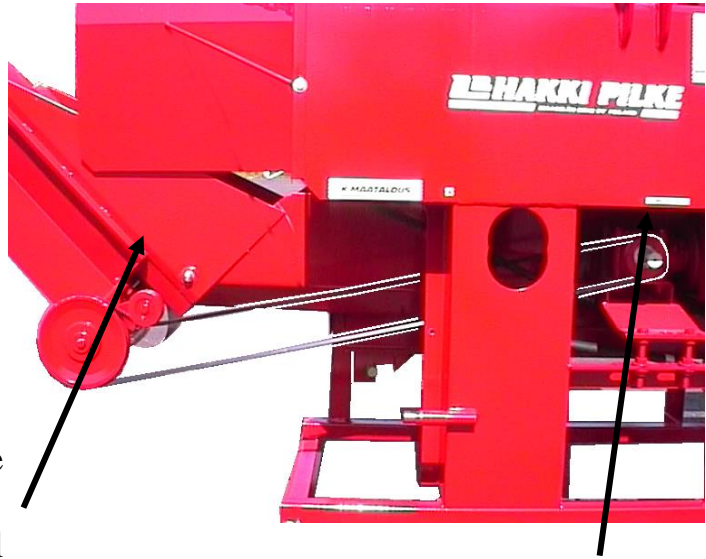

3. Place the belt on the pulley of the angular gear.

4. Put the belt cover in place.

Make sure that the inner side of the cover goes into the support groove on the conveyor shaft.

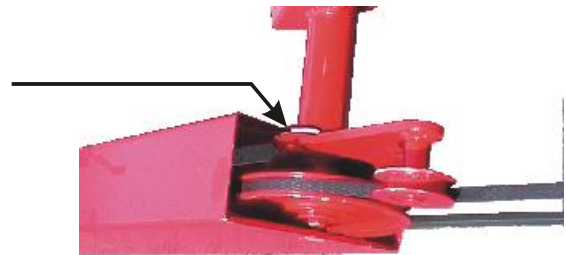

5. Attach the cover to the machine frame with a bolt and nut.



Note! When installing the belt, remove the belt retaining bolt if necessary!

Tightening Angular Gear Drive Belts in Model TR60



1. Open the locking of the belt adjustment.

2. Open the locking of the adjustment nut.

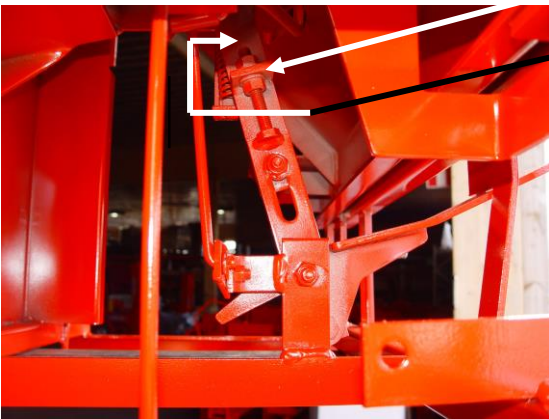

3. Achieve the correct belt tightness by turning the adjustment nut.

Belt tightness:

The belts should give way approx. 15 to 20 mm when pushed down between the pulleys.



4. Tighten the locking of the adjustment.

Tightening Angular Gear Drive Belts in Model TRS60



Locking

Belt tightening (electric motor)

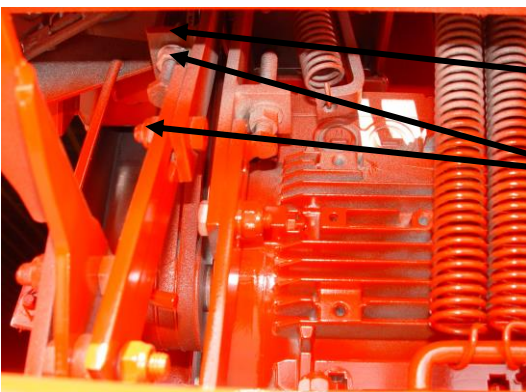

Belt tightening

Angular gear belt locking

Machine Lubrication

Protect yourself when handling lubricants to prevent them from causing problems to your skin. When handling lubricants, make sure they do not end up in the environment.



Apply grease on the points marked with this yellow symbol.

Hydraulic Oil



Change the hydraulic oil and filter at intervals of approx. 500 operating hours or every other year.

The filling hole for hydraulic oil: there is a dipstick in the cap, with a mark indicating the correct oil level.

Hydraulic oil: normal hydraulic oil
E.g. Neste 32.

Hydraulic filter: cartridge type CR 50.

Hydraulic oil tank: capacity 40 l.

Angular Gear

The correct oil level:

In the horizontal position, oil flows out through the filling hole.



Change the oil of angular gear at intervals of approx. 1,000 operating hours.

Splitting Mechanism

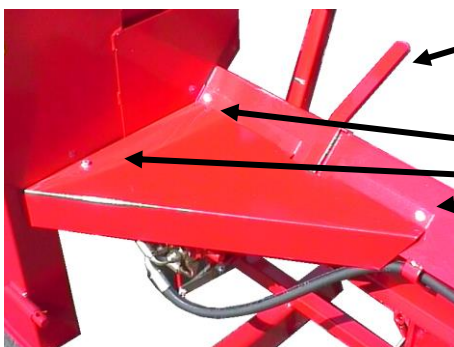

Splitting control lever

The splitting mechanism is located in front of the cross-cut cradle.

The mechanism can be adjusted by removing the cover and its locking bolts.

Operation

In the initial position, the valve joint lever is in its centre position.



When the cut wood hits the sensor in the splitting chute, the other end of the release lever lifts up, and the joint lever that controls the valve is pushed to the right, thrust by the spring.

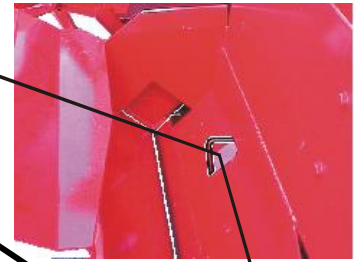

The splitting movement starts as the joint lever moves to the right.

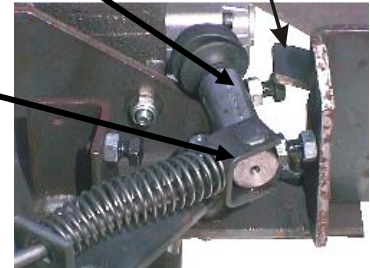

As the splitting cylinder/beam approaches the splitting blade, the turning rod attached to the splitting beam will swing the turning lever to its extreme right position. Thus the valve joint lever goes to its extreme left position, thrust by the spring.



Turning lever

Turning rod

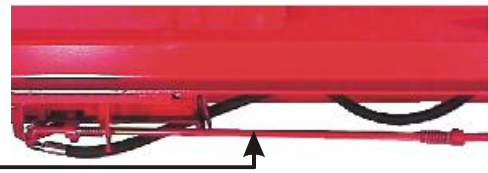

When the joint lever moves to its extreme left position, the splitting beam will reverse. As the splitting beam arrives at its initial position, the turning rod will swing the turning lever to its extreme left position.

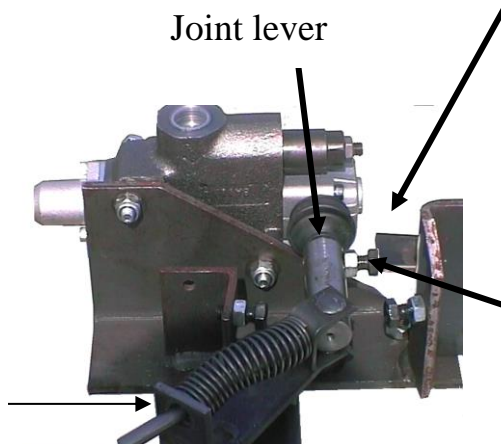

Joint lever

The splitting release lever returns to its down position during the splitting movement.

With the turning lever in its left position, the spring pushes the joint lever to the right.

However, the joint lever stops against the splitting release lever, which has dropped down, and the joint lever stays in its centre position.

Adjustments

Valve spool
direction

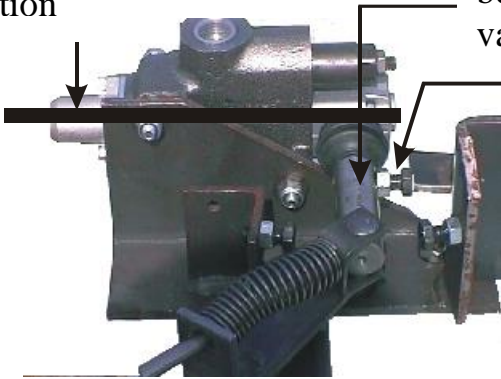

The joint lever, which controls the valve spool, must be in its centre position at a 90° angle in relation to the valve spool.

The centre position of the joint lever can be adjusted with the bolt and locking nut at its side.

Adjusting the Travel of the Splitting Beam

A turning rod with stoppers is located under the splitting beam. The initial position and the point of return of the splitting beam from near the splitting blade can be adjusted by changing the position of these stoppers.

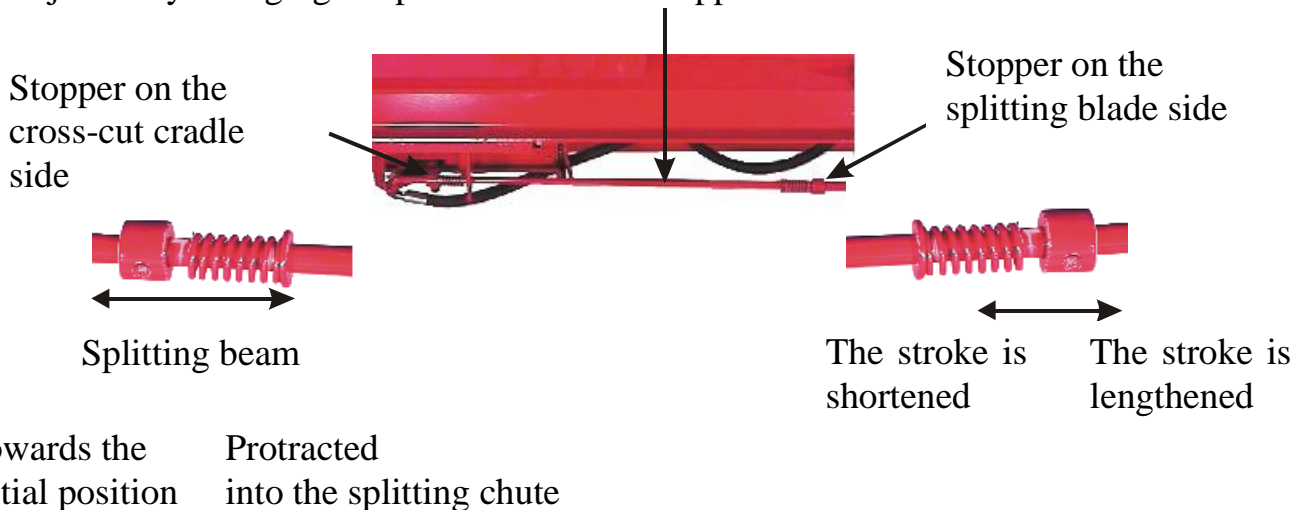

NOTE! Adjust the extreme positions of the splitting movement so that the joint lever will work and make the splitting beam reverse from the splitting blade all the way to its initial position.

Disturbances in the Splitting Mechanism, Their Reparation and Prevention

When changing the direction of the splitting movement, the joint lever swings from one extreme position to the other, thrust by the spring force.

As the joint lever slams into its extreme position, a limiter bolt must cushion its movement.

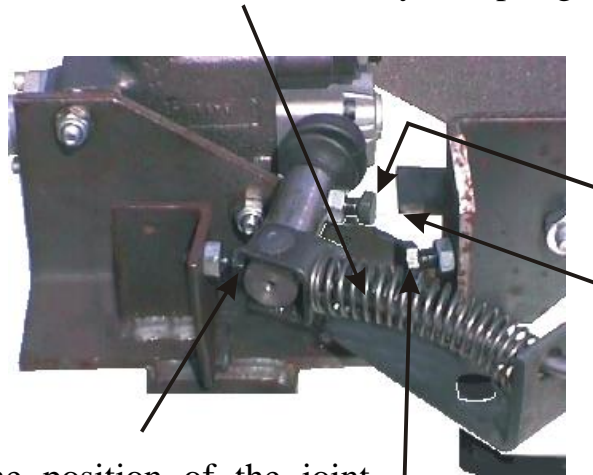

Adjust the position of the joint lever with the limiter by approx. 2 mm towards the centre position to make the swing blow hit the bolt in the head.

Remember to adjust both sides!

If the machine performs the splitting movement and neither the splitting release pedal nor the automatic release lever have been touched, the reason can be one of the following:

Either the head of the adjustment bolt by the side of the joint lever has become rounded at its upper part, or the release lever bar has become rounded at its lower part.

When rounded, the bolt head and bar cannot keep the joint lever in the centre position; when the joint lever approaches from the left, it continues straight to the right edge, and a new splitting movement commences.

Repair the fault by turning the head of the bolt to a new position. Make sure that the centre position of the joint lever does not move more than approx. 2 mm in either direction. Should the centre position move more, the oil will flow through the valve to the cylinder and the splitting beam will move slowly forward from its initial position or it will continue its reverse movement until the piston and the piston rod of the cylinder reach their extreme position. There is no space for oil in the cylinder in the extreme position, and the pressure will start to rise, thus stressing the entire hydraulic system. As the pressure rises, the power requirement of the machine will increase, and at the pressure of 180 bar the pressure relief valve will open, letting the oil flow through.

Should the joint lever slam into its extreme position without being cushioned by a bolt, the ball joint moving the valve spool will break.

The whole splitting system will be paralysed if the ball joint breaks.

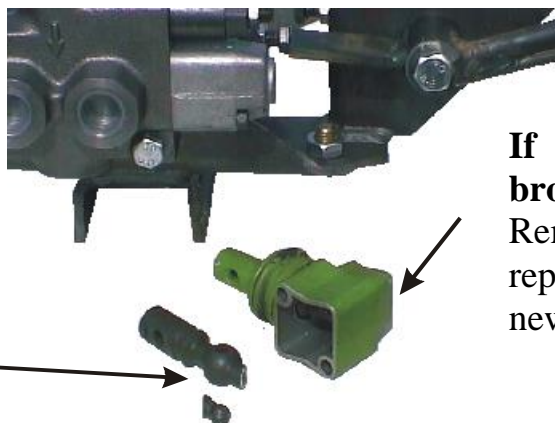

If the ball joint has broken:

Remove its cover box and replace the ball joint with a new one.

Hydraulic System Pressure Adjustment

There is a pressure adjustment screw with a locking nut at the joint lever end of the valve: screwing inwards will increase the pressure.

Max. pressure is 180 bar. Remember the locking!



Storing the Machine

The machine must be stored in a covered place where it is protected from collisions.

Technical Specifications:

Power requirement	7.5 kW
Effect	3–6 m ² /h
Cutting blade diameter	700 mm
Cylinder diameter / expulsive force	50 mm / 3.5 t
- optional	63 mm / 5.5 t
Flow of hydraulic	39 l/min
Volume of the oil tank / oil in tank	50 l / 40 l
Pressure of the hydraulic system	180 bar
Weight of the machine	490 kg (tr), 650 kg (combi)
Dimensions of the machine	
- height	2,500 mm
- depth	800 mm
- width	2,500 mm
Noise level	
Sound pressure level at the operator's position	100 dB
Sound power level	110 dB
Maximum noise level at the operator's position	<130 dB (126 dB)
Weighted acceleration of hand vibration	<2.5 m/s

VAT number FI 0550899-7

MAASELÄN KONE OY
VALIMOTIE 1
85800 HAAPAJÄRVI, FINLAND
+358 (0) 8 7727300

EU DECLARATION OF CONFORMITY OF MACHINE
(Machine Directive 2006/42/EC, Appendix II A)

Manufacturer: Maaselän Kone Oy

Address: Valimotie 1, FI-85800 Haapajärvi, Finland

Name and address of the person who is authorized to collect technical file:

Name: Timo Jussila

**Address: Valimotie 1, FI-85800
Haapajärvi, Finland**

Declares that

Hakki Pilke OH27

Serial number:.....

- **is compatible with relevant regulations of the Machine Directive (2006/42/EC)**
- **is compatible with the following other EC-Directives:
EMC-Directive 2004/108/EC and Low Voltage Directive 2006/95/EC**

EC standards inspection certificate number: 31/2010

Institution approval number 0504

MTT Vakola

Vakolantie 55

03400 Vihti, Finland

Place, time: Haapajärvi, June 8. 2017



*Anssi Westerlund
Managing Director*

Guarantee terms

“Guarantee terms come into force when you register your customership in the extranet service found on our website.”

The guarantee is valid for the original buyer for 12 months, starting from the date of purchase, but for no more than 1 000 operating hours. In guarantee matters, always contact the machine's seller before undertaking any procedures.

A guarantee demand has to be issued to the seller **immediately** upon discovery of a defect. If the defect concerns a damaged part or component, please send a photograph of the damaged part or component to the seller, if possible, so the fault can be identified. When submitting a guarantee claim, the buyer must always include the type and serial number of the machine and present a receipt that includes the date of purchase. Guarantee claims must be submitted to an authorised retailer.

The guarantee covers

- Parts damaged in normal use due to faults in material or manufacture.
- Reasonable expenses caused by repairing a fault in accordance with the agreement between the seller or buyer and manufacturer. Faulty parts will be replaced with new ones. A faulty part or parts replaced due to a material fault should be returned to the manufacturer through the retailer.

The guarantee does not cover

- Damages caused by normal wear and tear (for example blades, mats and belts), improper use or use contrary to the instruction manual
- Damages caused by negligence of maintenance or storage procedures detailed in the instruction manual
- Damages caused during transport
- Cutting blades, V-belts and oil, and normal adjustment, care, maintenance or cleaning procedures
- Defects in a machine to which the buyer has carried out or commissioned structural or functional changes to the degree that the machine can no longer be considered equivalent to the original machine
- Other potential costs or financial obligations resulting from the procedures mentioned above
- Indirect costs
- Travel costs resulting from guarantee repairs
- The guarantee for parts replaced during the guarantee period of the machine expires at the same time as the machine's guarantee
- The guarantee is void if the ownership of the machine is transferred to a third party during the guarantee period
- The guarantee is void if any of the machine's seals have been broken

If a fault or defect reported by the customer is found to not be covered by the guarantee, the manufacturer has the right to charge the customer for the pinpointing and possible repair of the fault or defect in accordance with the manufacturer's current price list.

This guarantee certificate indicates our responsibilities and obligations in full and it excludes all other responsibilities.